



## MODEL 51101/51101C SERIES

### KEY FEATURES

- Models with 1, 8, and 64 channels on-line data recording. Multi-sets linked to a PC for hundreds of channels are doable
- Support B, E, J, K, N, R, S, and T type thermal couples with ITS-90 defined temperature range
- Individual channel cold junction compensation with  $\pm 0.5^{\circ}\text{C}$  accuracy
- Temperature resolution up to  $0.01^{\circ}\text{C}$ , error down to (0.01% of reading +  $0.5^{\circ}\text{C}$ )
- VA-480 voltage adaptor :  
Voltage range  $\pm 480\text{VDC}$  ; Resolution 1mV ; Accuracy 0.1% of reading + 1mV
- VA-10 voltage adaptor :  
Voltage range  $\pm 10\text{VDC}$  ; Resolution 100uV ; Accuracy 0.05% of reading + 500uV
- 1000VDC channel to channel isolation, full protection for testing points with charge and guarantee for accurate measurements
- Thermal couple open circuit detection
- PC-based operation with powerful software for recording and analyzing data
- 1 and 8 channel models are USB powered. No battery or external power supply is required

## THERMAL/MULTI-FUNCTION DATA LOGGER MODEL 51101/51101C SERIES

It is a general requirement to record temperatures, voltages, currents, and many physics quantities during research, product development, productions, and quality assurance processes. The number of record channels can be a simple one to several complicated set of hundreds. Thermal/multi-function data loggers are perfect solutions to serve for these measurement and tracking needs.

There are several measurement products in the market to perform such a large-scale and extensive time varying recording. Some are expensive, some are limited in accuracy or resolution, and some have low immunity to interference. Chroma thermal/multi-function data loggers are by far the most cost-effective solutions for versatility, accuracy, stability, and interference immunity among this category.

Chroma thermal/multi-function data loggers measure temperatures, voltages, and currents with high accuracy and resolutions. For example, they support 8 types of thermal couples measurement with ITS-90 defined temperature range at  $0.5^{\circ}\text{C}$

accuracy and  $0.01^{\circ}\text{C}$  resolution\*, while most data loggers in the market are at  $1^{\circ}\text{C}$  accuracy and  $0.1^{\circ}\text{C}$  resolution\*. Chroma loggers are with 1000VDC channel to channel isolation, which means they can attach thermal couples to objects with high electricity, such as batteries, solar cells, working PCB, etc., and still get correct data. Many competitors are just malfunctioned or even damaged in those cases. Data retrieve in Chroma loggers are in a parallel architecture, while most of competitors use a sequential multiplexing method. This means data rate per channel is quick and constant for Chroma loggers, while others become much slower when number of channels is bigger.

Using Chroma thermal/multi-function data loggers, customers get confidence in measured data and high Performance/Cost ratio. Most of all, we can help in certain cases that our competitors fail, and only Chroma succeeds.

\*Thermal couple error excluded. Please see specification list for detail.



# Chroma

## 1000VDC CHANNEL TO CHANNEL ISOLATION

In developing or qualifying some electronic devices, tracking records of temperatures/voltages/currents are required. Many cases there can be high voltage difference between measured points. A switching power supply, for example, is required to measure the primary side voltage/current, secondary side voltage/current, and key component temperatures. Unfortunately, many data loggers including some leading brands are incapable to handle such a high voltage difference between both sides. Few hundred voltage difference can mess up their measurement totally, or even kills their loggers.

Chroma thermal/multifunction data loggers are perfect for the measurements in a situation with charge and high voltage difference. The feature of 1000VDC channel to channel isolation makes them immune to voltage difference between any two channels. One just attaches thermal couples or wires on the device or conducting pads and gets accurate data.

Another case can be battery system tests. One needs to know the voltage and temperature of each cell. For other data loggers, often the voltages cannot be measured properly in the cascade configuration. The thermal couple attachment is another issue needing special care. All these problems are easily solved using Chroma thermal/multi-function data loggers for the high channel to channel isolation.

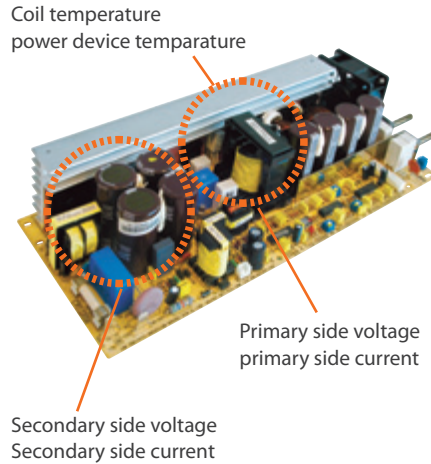

Multi-channel Data Logger



## 0.5 °C ACCURACY AND 0.01 °C RESOLUTION

For the same or even lower prices, Chroma thermal/multi-function data logger offers higher accuracy and better resolution than our competitors do. While most of data loggers are at 1°C accuracy and 0.1°C resolution, Chroma data loggers are 1 order better than theirs. It is always true the more accurate and seeing more details, the better for measurements.

In order to achieve such high accuracy and resolution, Chroma implements individual CJC for each channel. High bit-count A-to-D converters and advanced noise suppression circuit makes outstanding performance for these data loggers. The best of all is that customers can enjoy better specifications without paying more.

Precise temperatures can be critical in thermal conductivity measurements, chemical processes, and biologic experiments. Testing a heat pipe, for example, often requires resolving <1°C temperature difference between evaporation and condensing zones. Some liquid crystals can change their properties drastically with a very small temperature variation at critical temperatures.

## CONSTANT DATA RATE PER CHANNEL

Most of data loggers in the market use a multiplexing circuit structure. All channels share a bandwidth which means the more active channels, the slower data rate per channel will be. Chroma data loggers use a parallel data retrieving circuit structure. No matter how many channels are active, the data rate can be as fast as 5 samples per second per channel.

The benefit of constant data rate can be profound for recording large number of channels. For tens of channels, total data bandwidth of Chroma data logger can be several times larger than that of other data loggers. Some other data loggers can become too slow and lose details. They can miss recording critical changes happen in a short time. Chroma data loggers greatly reduce this possibility.

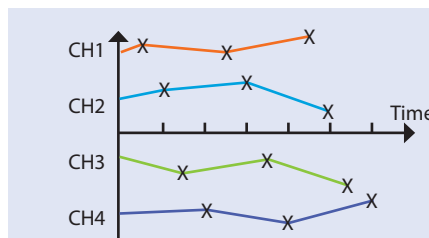

What other data loggers see,  
more channels, slower rate each channel

$$\text{Sample rate per channel} = \frac{\text{bandwidth}}{\text{number of channels}}$$

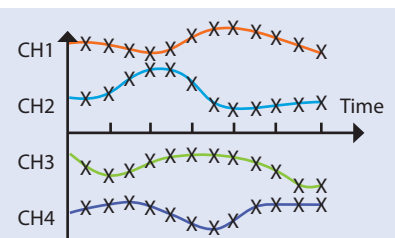

What CHROMA data loggers see,  
constant rate each channel

$$\text{Sample rate per channel} = \text{constant}$$

## POWERFUL DATA RECORDING AND ANALYZING THROUGH A PC

Personal computers and Notebooks are powerful for their fast calculation and data processing capability, friendly graphic user interface, and huge hard disk storage. While operation of many other data loggers are limited by their small display and memory, Chroma data loggers link to PCs or Notebooks for direct display, analyses, and storage.

Using the PC software, one can see the detail of all the curves, change drawing time and range scales, create marks, zoom in selected sections, and perform difference calculations, all in few simple steps. The PC RAM is used as buffer to store every data since the logger is powered on, making data tracking back possible without opening the record file. Size of data recording is determined by hard disk free space, which is almost unlimited.

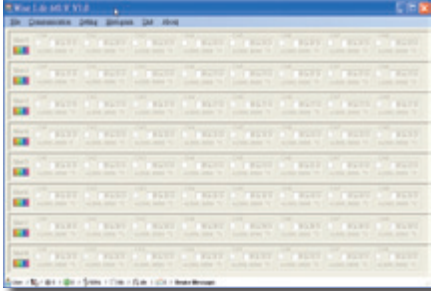

Main panel

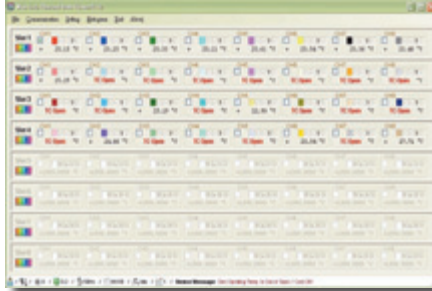

Data panel

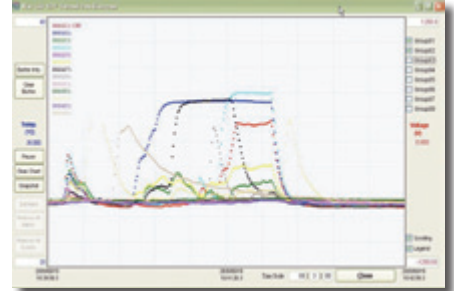

Data Histogram

## APPLICATIONS



Automotive & Aircraft



Electrical & Electronics



Solar Energy



Power



Machinery



Iron & Steel



Metals & Mining



Oil & Gas



Water & Waste



Chemical



Pharmaceutical & Food



Others

## SPECIFICATIONS

Model	51101-1 51101C-1	51101-8 51101C-8	51101-64 51101C-64 *4
<b>Thermocouple</b>			
Thermocouple T-type	-200 to 400°C	51101 Series : $\pm (0.01\% \text{ of reading} + 0.5) ^\circ\text{C} *1$ 51101C Series : $\pm (0.01\% \text{ of reading} + 0.8) ^\circ\text{C} *1$	
Thermocouple K-type	-200 to 1372°C		
Thermocouple B-type	250 to 1820°C		
Thermocouple E-type	-200 to 1000°C		
Thermocouple J-type	-210 to 1200°C		
Thermocouple N-type	-200 to 1300°C		
Thermocouple S-type	-50 to 1760°C		
Thermocouple R-type	-50 to 1760°C		
Thermocouple Jacks		B, E, J, K, N, R, S, or T mini-type	
Thermocouple Connector		B, E, J, K, N, R, S, or T mini-type	
<b>Temperature Reading</b>			
Number of Inputs	1	8	8, 16, 24, 32, 40, 48, 56, 64 channel
Temperature Sensor Type	Thermocouple : B, E, J, K, N, R, S, T		
Temperature Scale	ITS-90		
Temperature Resolution	$\pm 0.01 ^\circ\text{C}$		
Temperature Accuracy *1*2	51101 Series : $\pm (0.01\% \text{ of reading} + 0.5) ^\circ\text{C}$ 51101C Series : $\pm (0.01\% \text{ of reading} + 0.8) ^\circ\text{C}$		
CJC Error	51101 Series : $\pm 0.5 ^\circ\text{C}$ 51101C Series : $\pm 0.8 ^\circ\text{C}$		
Maximum Sample Rate	5 sample/sec.		
Channel to Channel Isolation	1000VDC / 750 Vrms		
Input Resistance	5M $\Omega$		
Thermocouple break detection current	100 nA		

Continued on next page ➔

## SPECIFICATIONS

Digital I/O			
Number of Digital I/O	--	--	4 differential digital inputs and outputs
Digital Input	--	--	1 trigger input(DI0) and 3 general purpose inputs
Digital Input- High Input Voltage	--	--	3 ~ 30 V
Digital Input- Low Input Voltage	--	--	< 0.8 V
Digital Input- High Input Current	--	--	0.8 ~ 13.1 mA
Digital Input- Low Input Current	--	--	<10 $\mu$ A
Digital Input- Terminal Resistor	--	--	2.2K $\Omega$
Digital Output Configuration	--	--	transistor switch
Digital Output- External Supply Voltage	--	--	<30 V
Digital Output- ON-state Voltage	--	--	<1.5 V
Digital Output- ON-state Current	--	--	<400 mA
Digital Output- OFF-state Current	--	--	<2.1 $\mu$ A
Digital Output- Power Dissipation per Output	--	--	<0.6 W
Isolation Voltage	--	--	$\pm$ 250 V
Communication			
RS-232	--	--	Half Duplex, DB-9 female connector
USB	USB2.0 (full speed device) ; USB A-type connector	--	USB2.0 (full speed device) ; USB B-type connector
LAN	--	--	10/100 Mbps
Power Specifications			
Power Requirement	--	4.5~5.5 V	11.4~12.6 V
Maximum Power Consumption	0.22W	1.2W	18 W
Physical Specifications			
Dimensions (WxDxH)	96 x 29 x 14.5mm	135.3 x 186 x 51.7 mm	277 x 200.7 x 233 mm
Weight for Main Frame	30g	1.2 Kg	2.4 Kg
Weight per Sensor Card	--	--	0.15 Kg
Weight (Main Frame + 8 Sensor Card)	--	--	3.6 Kg
Environmental specifications			
Operating Temperature *1*2	--	0~50°C	--
Humidity	--	< 80 %RH	--
Power Adaptor Input Voltage	--	--	90 to 260 VAC
Power Adaptor Input Frequency	--	--	47 to 63 Hz
Main Frame DC Input	--	--	12.6 V/1.5 A
Thermocouple Differential Input Voltage Limit	$\pm$ 1.2 V	$\pm$ 1.2 V	$\pm$ 1.2 V
Operating Temperature	--	0~50°C	--
Storage Temperature	--	-20~60°C	--
Storage Humidity	--	80 %RH	--
Voltage Reading			
Voltage Input Type	VA-480 Voltage Adaptor	VA-10 Voltage Adaptor	
Voltage Resolution	1mV	100uV	
Voltage Input Range	$\pm$ 480VDC	$\pm$ 10VDC	
Voltage Input Accuracy	$\pm$ (0.1% of reading + 1mV)*3	$\pm$ (0.05% of reading + 500uV)*3	
Input Resistance	1M $\Omega$	300 K $\Omega$	
Current Reading			
Current Input Type	IA-3 Current Adaptor		
Current Resolution	1mA		
Current Input Range	$\pm$ 3A		
Current Input Accuracy	$\pm$ (1% of reading + 1mA)		

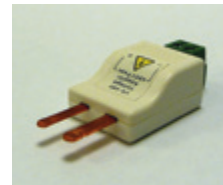

Voltage/Current Adaptor



Thermal Coupler

**Note \*1** : Measure after heat equilibrium is reached and the uncertainty of thermocouple itself is excluded. Operating temperature from 20°C to 30°C

**Note \*2** : For operating temperature out of range from 20°C to 30°C, additional error (0.01% of reading + 0.03°C) / °C for that out of operating temperature should be added

**Note \*3** : Under MV\_8 filtering mode

**Note \*4** : Model 51101-64/51101C-64 with LAN module

All specifications are subject to change without notice.

## ORDERING INFORMATION

**51101-1** : Thermal/Multi-Function Data Logger - 1 channel

**51101C-1** : Thermal/Multi-Function Data Logger - 1 channel

**51101-8** : Thermal/Multi-Function Data Logger - 8 channel

**51101C-8** : Thermal/Multi-Function Data Logger - 8 channel

**51101-64** : Thermal/Multi-Function Data Logger - 64 channel

**51101C-64** : Thermal/Multi-Function Data Logger - 64 channel

**A511000** : VA-480 Voltage Adaptor (option)

**A511001** : IA-3 Current Adaptor (option)

**A511002** : VA-10 Voltage Adaptor (option)

**A511003** : 8-port sensor card with package

**A511004** : C8-port sensor card with package

## Distributed By:

**Signal Test, Inc**

**1529 Santiago Ridge Way**

**San Diego, CA 92154**

**Tel. 1-619-575-1577 USA**

**www.SignalTestInc.com**

**Sales@SignalTestInc.com**

**SIGNAL TEST™**  
New & Used Test Equipment